

A6 package: 750V 950A IGBT module

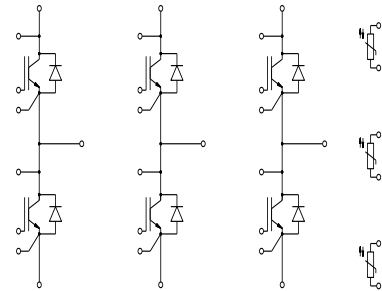
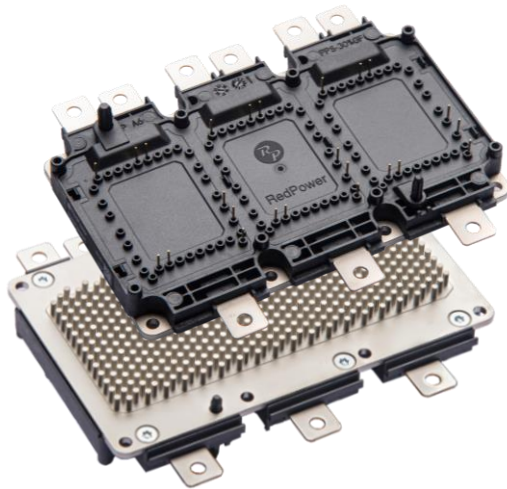

等效电路图
Equivalent Circuit Schematic

Features:

- 750V 950A, $V_{CE(sat)} = 1.43V @ 25^{\circ}C$
- Direct cooled PinFin Base Plate
- Micro pattern trench/FS Technology
- Low switching losses

产品特性:

- 750V 950A, $V_{CE(sat)} = 1.43V @ 25^{\circ}C$
- PinFin 直接液冷散热底板
- 微沟槽栅/场终止技术
- 低开关损耗

Typical Applications:

- Electric Vehicles
- Motor Drives

典型应用:

- 电动汽车
- 电机驱动

IGBT, Inverter / IGBT, 逆变部分
Maximum Rated Values / 最大标称参数

Collector-emitter voltage 集电极-发射极电压	$T_{vj}=25^{\circ}\text{C}$	V_{CES}	750	V
Implemented collector current 连续集电极电流		$I_{C\text{ nom}}$	950	A
Continuous DC collector current 集电极连续直流电流	$T_F=95^{\circ}\text{C}, T_{vj\text{ max}}=175^{\circ}\text{C}$	I_C	525 ¹⁾	A
Repetitive peak collector current 集电极可重复峰值电流	$t_p=1\text{ms}$	I_{CRM}	1900 ¹⁾	A
Gate-emitter peak voltage 门极-发射极峰值电压		V_{GES}	± 20	V

Characteristic Values / 性能参数

			min.	typ.	max.	
Collector-emitter saturation voltage 集电极-发射极饱和压降	$I_C=450\text{A}, V_{GE}=15\text{V}$	$T_{vj}=25^{\circ}\text{C}$ $T_{vj}=150^{\circ}\text{C}$ $T_{vj}=175^{\circ}\text{C}$	$V_{CE\text{ sat}}$	1.15 1.17 1.17	1.45	V
	$I_C=950\text{A}, V_{GE}=15\text{V}$	$T_{vj}=25^{\circ}\text{C}$ $T_{vj}=175^{\circ}\text{C}$		1.43 1.65	1.9	
Gate threshold voltage 门极阈值电压	$V_{CE}=V_{GE}, I_C=9.6\text{mA}$,	$T_{vj}=25^{\circ}\text{C}$ $T_{vj}=175^{\circ}\text{C}$	$V_{GE\text{ th}}$	5.0 6.0 3.8	7.0	V
Internal gate resistor 内置门极电阻		$T_{vj}=25^{\circ}\text{C}$	$R_{G\text{ int}}$	0.43		Ω
Input capacitance 输入电容	$V_{CE}=25\text{V}, V_{GE}=0\text{V}, f=100\text{kHz}, T_{vj}=25^{\circ}\text{C}$		C_{ies}	106		nF
Reverse transfer capacitance 反向传输电容	$V_{CE}=25\text{V}, V_{GE}=0\text{V}, f=100\text{kHz}, T_{vj}=25^{\circ}\text{C}$		C_{res}	0.39		nF
Gate charge 门极电荷	$V_{GE}=-8\text{V}\sim+15\text{V}, V_{CE}=400\text{V}$		Q_G	4.38		μC
Collector-emitter cutoff current 集电极-发射极关断漏电流	$V_{CE}=750\text{V}, V_{GE}=0\text{V},$	$T_{vj}=25^{\circ}\text{C}$	I_{CES}		1	mA
Gate-emitter leakage current 门极-发射极漏电流	$V_{CE}=0\text{V}, V_{GE}=20\text{V},$	$T_{vj}=25^{\circ}\text{C}$	I_{GES}		400	nA
Turn-on delay time, inductive load 开通延迟时间, 感性负载	$I_C=450\text{A}, V_{CE}=400\text{V}$ $V_{GE}=-8\text{V}/15\text{V}$ $R_{Gon}=1.0\Omega$	$T_{vj}=25^{\circ}\text{C}$	t_{don}	140		ns
		$T_{vj}=150^{\circ}\text{C}$		160		
		$T_{vj}=175^{\circ}\text{C}$		162		
Rise time, inductive load 上升时间, 感性负载	$I_C=450\text{A}, V_{CE}=400\text{V}$ $V_{GE}=-8\text{V}/15\text{V}$ $R_{Gon}=1.0\Omega$	$T_{vj}=25^{\circ}\text{C}$	t_r	53		ns
		$T_{vj}=150^{\circ}\text{C}$		65		
		$T_{vj}=175^{\circ}\text{C}$		67		
Turn-off delay time, inductive load 关断延迟时间, 感性负载	$I_C=450\text{A}, V_{CE}=400\text{V}$ $V_{GE}=-8\text{V}/15\text{V}$ $R_{Goff}=5.0\Omega$	$T_{vj}=25^{\circ}\text{C}$	t_{doff}	756		ns
		$T_{vj}=150^{\circ}\text{C}$		863		
		$T_{vj}=175^{\circ}\text{C}$		890		
Fall time, inductive load 下降时间, 感性负载	$I_C=450\text{A}, V_{CE}=400\text{V}$ $V_{GE}=-8\text{V}/15\text{V}$ $R_{Goff}=5.0\Omega$	$T_{vj}=25^{\circ}\text{C}$	t_f	77		ns
		$T_{vj}=150^{\circ}\text{C}$		164		
		$T_{vj}=175^{\circ}\text{C}$		177		
Turn-on energy loss per pulse 开通损耗	$I_C=450\text{A}, V_{CE}=400\text{V}, L_s=30\text{nH}$ $V_{GE}=-8\text{V}/15\text{V}, R_{Gon}=1.0\Omega$ $di/dt(T_{vj}=25^{\circ}\text{C})=6750\text{A}/\mu\text{s}$ $di/dt(T_{vj}=150^{\circ}\text{C})=5500\text{A}/\mu\text{s}$	$T_{vj}=25^{\circ}\text{C}$	E_{on}	9.65		mJ
		$T_{vj}=150^{\circ}\text{C}$		13.8		
		$T_{vj}=175^{\circ}\text{C}$		15.2		
Turn-off energy loss per pulse 关断损耗	$I_C=450\text{A}, V_{CE}=400\text{V}, L_s=30\text{nH}$ $V_{GE}=-8\text{V}/15\text{V}, R_{Goff}=5.0\Omega$ $dv/dt(T_{vj}=25^{\circ}\text{C})=7600\text{V}/\mu\text{s}$ $dv/dt(T_{vj}=150^{\circ}\text{C})=4760\text{V}/\mu\text{s}$	$T_{vj}=25^{\circ}\text{C}$	E_{off}	22.2		mJ
		$T_{vj}=150^{\circ}\text{C}$		31.5		
		$T_{vj}=175^{\circ}\text{C}$		33.6		

¹⁾非测试值, 设计计算所得

SC data 短路耐量	$V_{GE}=15V/-8V$, $V_{CC}=400V$, $V_{CEmax} \leq 750V$	$t_p \leq 6\mu s, T_{vj}=25^\circ C$ $t_p \leq 3\mu s, T_{vj}=175^\circ C$	I_{sc}		5200 4100		A
Thermal resistance, junction to cooling fluid 结-冷却液热阻	Per IGBT, $\Delta V/\Delta t=10dm^3/min$ $T_F=25^\circ C$		R_{thJF}		0.092		K/W
Temperature under switching conditions 工作温度	t_{op} continuous for 10s within a period of 30s, occurrence maximum 3000 times over lifetime		$T_{vj op}$	-40 150		150 175	$^\circ C$

Diode, Inverter / 二极管, 逆变部分

Maximum Rated Values / 最大标称参数

Repetitive peak reverse voltage 可重复反向峰值电压	$T_{vj}=25^\circ C$	V_{RRM}	750	V
Implemented forward current 连续正向电流		$I_{F nom}$	950	A
Repetitive peak forward current 可重复正向峰值电流	$t_p=1ms$	I_{FRM}	1900 ¹⁾	A

Characteristic Values / 性能参数

			min.	typ.	max.		
Forward voltage 正向通态压降	$I_F=450A, V_{GE}=0V$	$T_{vj}=25^\circ C$	V_F	1.33	1.75	V	
		$T_{vj}=150^\circ C$		1.21			
		$T_{vj}=175^\circ C$		1.16			
Peak reverse recovery current 反向恢复峰值电流	$I_F=450A, V_R=400V$ $-di_F/dt=4000A/\mu s(T_{vj}=150^\circ C)$ $V_{GE}=-8V$	$T_{vj}=25^\circ C$	I_{RM}	343	2.1	A	
		$T_{vj}=150^\circ C$		398			
		$T_{vj}=175^\circ C$		420			
Recovery charge 反向恢复电荷	$I_F=450A, V_R=400V$ $-di_F/dt=4000A/\mu s(T_{vj}=150^\circ C)$ $V_{GE}=-8V$	$T_{vj}=25^\circ C$	Q_r	27.5		μC	
		$T_{vj}=150^\circ C$		47.5			
		$T_{vj}=175^\circ C$		55.5			
Reverse recovery energy 反向恢复损耗	$I_F=450A, V_R=400V$ $-di_F/dt=4000A/\mu s(T_{vj}=150^\circ C)$ $V_{GE}=-8V$	$T_{vj}=25^\circ C$	E_{rec}	7.4		mJ	
		$T_{vj}=150^\circ C$		15			
		$T_{vj}=175^\circ C$		17.3			
Thermal resistance, junction to cooling fluid 结-冷却液热阻	Per FRD, $\Delta V/\Delta t=10dm^3/min$ $T_F=25^\circ C$		R_{thJF}		0.134		K/W
Temperature under switching conditions 工作温度	t_{op} continuous for 10s within a period of 30s, occurrence maximum 3000 times over lifetime		$T_{vj op}$	-40 150		150 175	$^\circ C$

¹⁾ 非测试值, 设计计算所得

NTC-Thermistor/ NTC-热敏电阻
Characteristic Values / 性能参数

		min.	typ.	max.	
Rated resistance 标称电阻	$T_C=25^\circ\text{C}$	R_{25}	5.00		$\text{K}\Omega$
Deviation of R100 R100 偏移值	$T_C=100^\circ\text{C}$, $R_{100}=493.3\Omega$	$\Delta R/R$	-5	5	%
Power dissipation 功率耗散	$T_C=25^\circ\text{C}$	P_{25}		20	mW
B-value B 值	$R_2=R_{25} \exp[B_{25/50}(1/T_2-1/(298.15\text{K}))]$	$B_{25/50}$	3375		K
B-value B 值	$R_2=R_{25} \exp[B_{25/80}(1/T_2-1/(298.15\text{K}))]$	$B_{25/80}$	3414		K
B-value B 值	$R_2=R_{25} \exp[B_{25/100}(1/T_2-1/(298.15\text{K}))]$	$B_{25/100}$	3436		K

Module / 模块

Isolation test voltage 绝缘测试电压	RMS, $f=50\text{Hz}$, $t=1\text{min}$	V_{ISOL}	3.0		KV
Material of module baseplate 模块底板材料			Cu+Ni ¹⁾		
Internal isolation 内部绝缘			Si ₃ N ₄		
Creepage distance 爬电距离	Terminal to heatsink Terminal to terminal	d_{Creep}	9.0 9.0		mm
Clearance 电气间隙	Terminal to heatsink Terminal to terminal	d_{clear}	4.5 4.5		mm
Comparative tracking index 相对漏电起痕指数		CTI	200 ²⁾		

min. typ. max.

Stray inductance module 模块杂散电感		L_{sCE}	8.5		nH
Module lead resistance, terminals-chip 模块引脚电阻, 端子-芯片	$T_C=25^\circ\text{C}$, Per switch	$R_{\text{CC}'+\text{EE}'}$	0.75		m Ω
Storage temperature 贮存温度		T_{stg}	-40	125	$^\circ\text{C}$
Mounting torque for module mounting 模块安装力矩	Baseplate to heatsink, Screw M4	M	1.8	2.2	Nm
	Terminal connection, Screw M5		3.6	4.4	
	PCB to frame		0.5	0.6	
Weight 重量		G	715		g

1) 铜底板表面镀镍

2) CTI 约为 200

Circuit Diagram / 曲线图

Output characteristic , Inverter IGBT (typical)

输出特性, 逆变IGBT (典型)

$I_C=f(V_{CE})$, $V_{GE}=15V$ (Inclusive $R_{CC'+EE'}$)

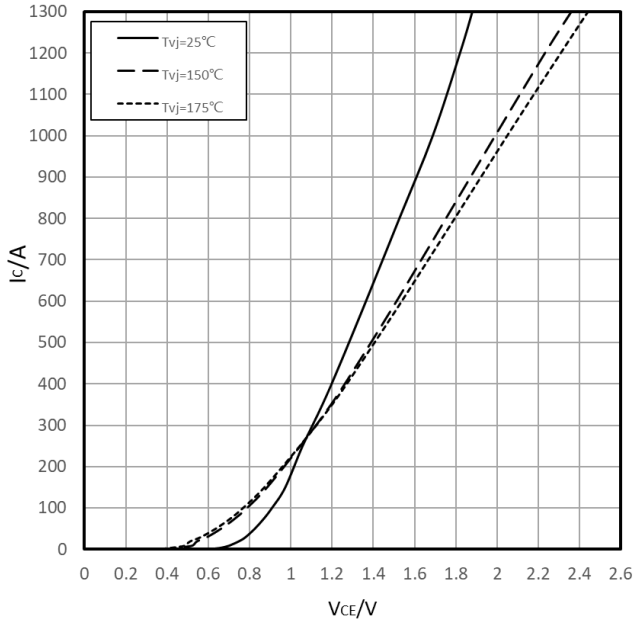

Output characteristic , Inverter IGBT (typical)

输出特性, 逆变IGBT (典型)

$I_C=f(V_{CE})$, $T_{vj}=150^\circ C$

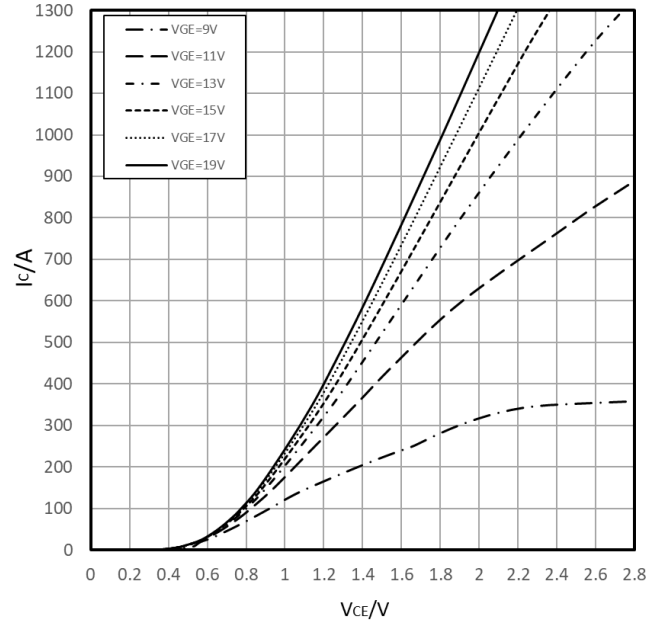

Transfer characteristic , Inverter IGBT (typical)

传输特性, 逆变IGBT (典型)

$I_C=f(V_{GE})$, $V_{CE}=20V$

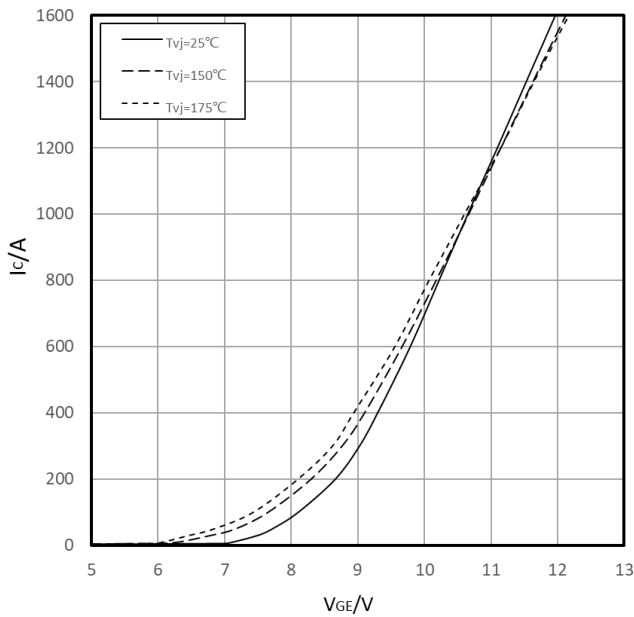

Switching losses , Inverter IGBT (typical)

开关损耗, 逆变IGBT (典型)

$E_{on}=f(I_C)$, $E_{off}=f(I_C)$

$V_{GE}=+15V/-8V$, $R_{gon}=1.0\Omega$, $R_{goff}=5.0\Omega$, $V_{CE}=400V$

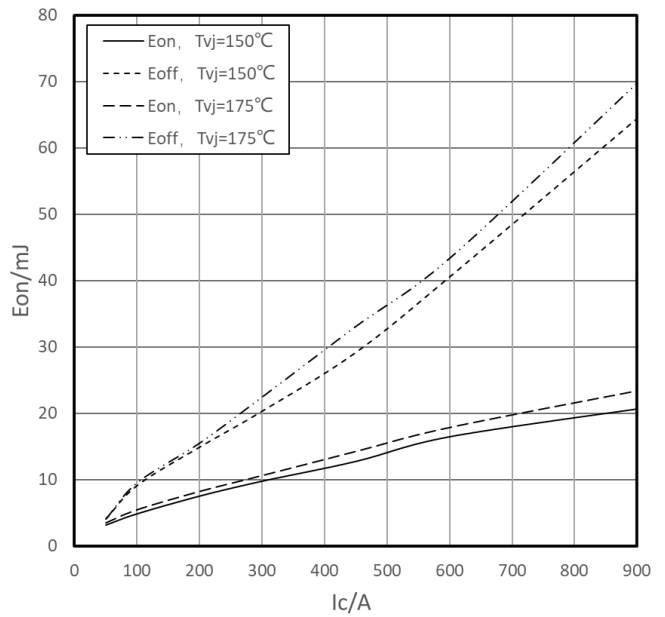

Switching losses , Inverter IGBT (typical)

开关损耗, 逆变IGBT (典型)

$E_{on}=f(R_g), E_{off}=f(R_g)$

$V_{GE}=+15V/-8V, I_c=450A, V_{CE}=400V$

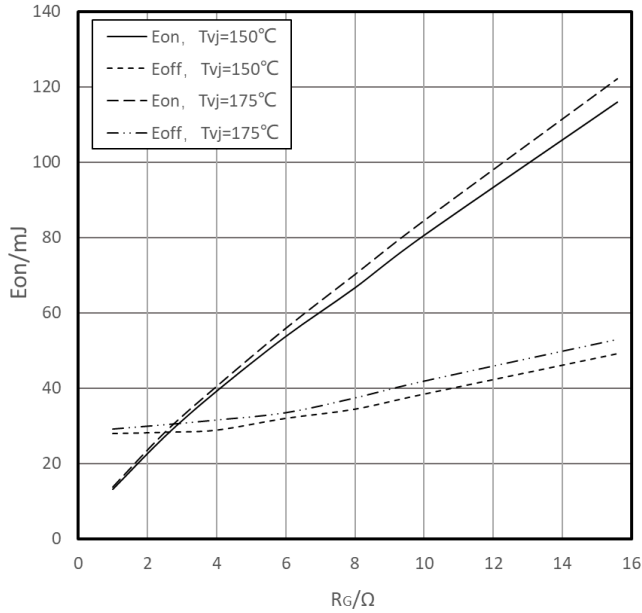

Transient thermal impedance IGBT, Inverter

瞬态热阻, 逆变IGBT

$Z_{th}=f(t)$

$\Delta V/\Delta t=10dm^3/min; T_f=25^\circ C; 100\% \text{ wafer}$

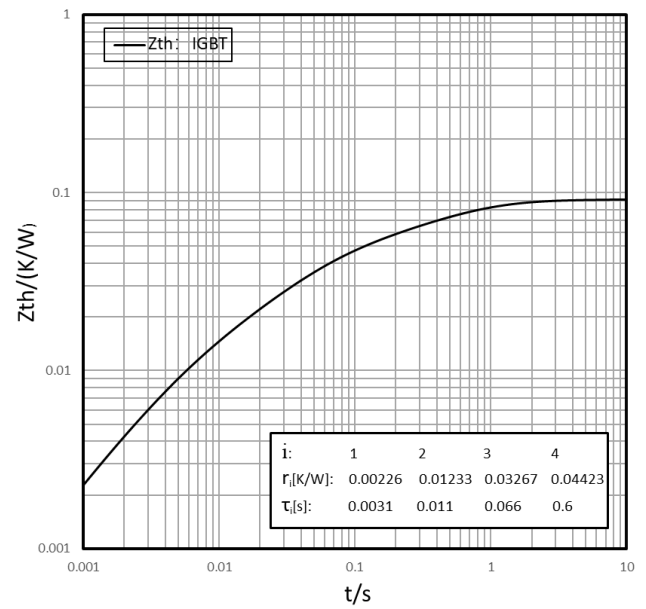

Reverse bias safe operating area , Inverter IGBT (RBSOA)

反偏安全工作区, 逆变IGBT (RBSOA)

$I_c=f(V_{CE}), V_{GE}=+15V/-8V, R_{goff}=5.0\Omega, T_{vj}=175^\circ C$

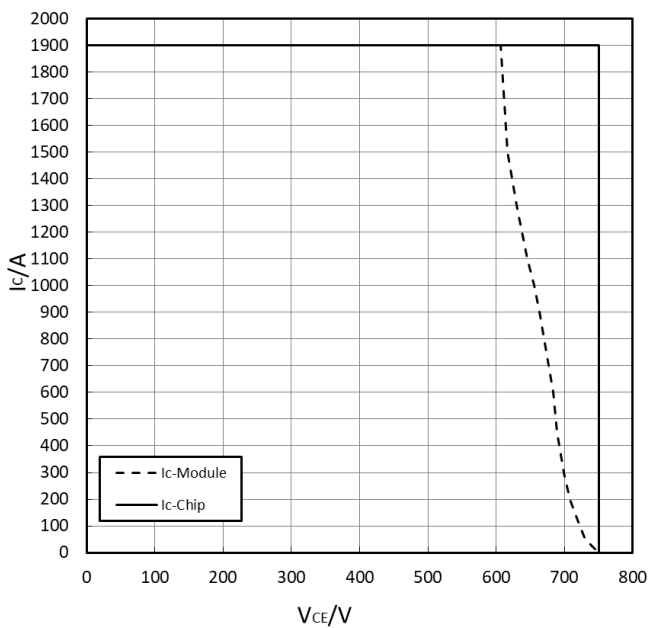

Forward characteristic , Inverter FRD (typical)

正向偏压特性, 逆变FRD (典型)

$I_f=f(V_f)$ (Inclusive R_{CC+EE})

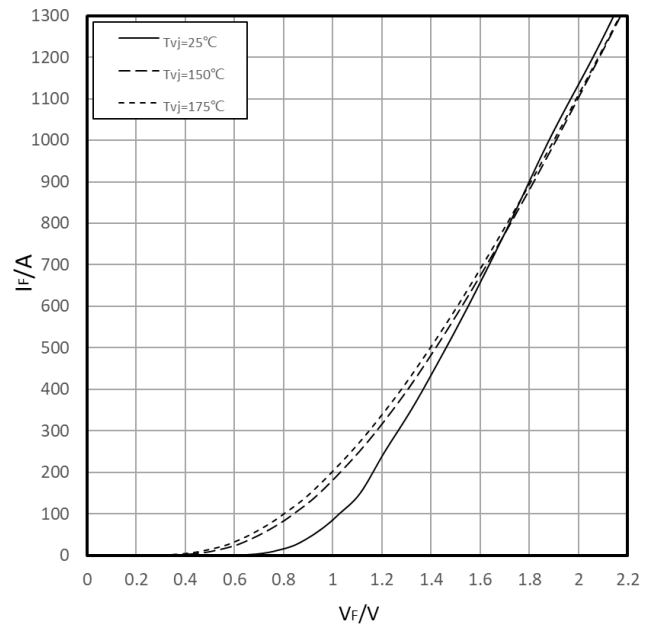

Switching losses , Inverter IGBT (typical)

开关损耗, 逆变FRD (典型)

$E_{rec}=f(I_F), R_{gon}=1.0\Omega, V_{CE}=400V$

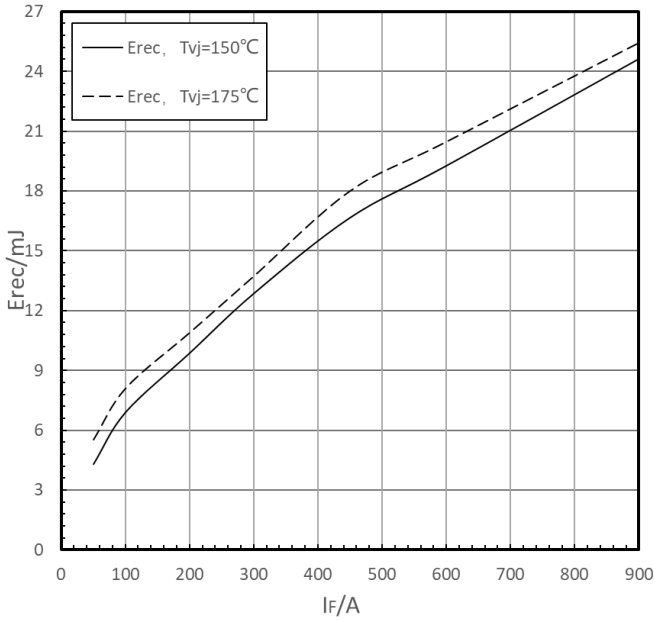

Switching losses , Inverter FRD (typical)

开关损耗, 逆变FRD (典型)

$E_{rec}=f(R_G), I_F=450A, V_{CE}=400V$

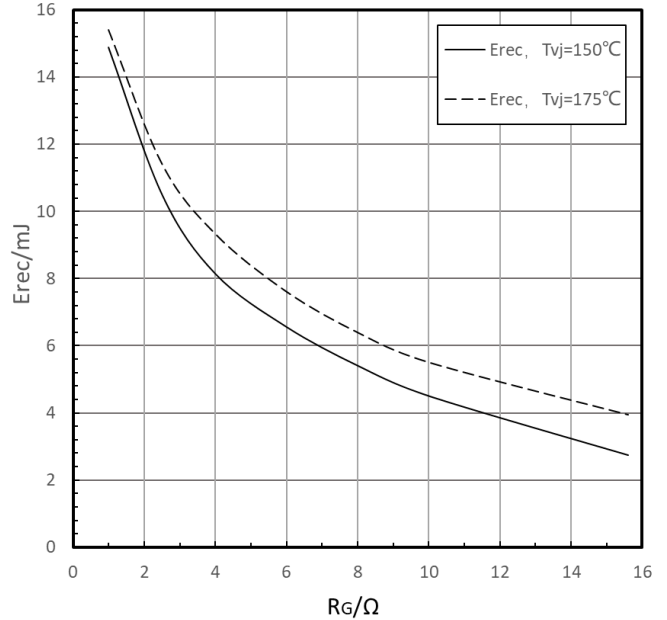

Transient thermal impedance FRD, Inverter

瞬态热阻, 逆变FRD

$Z_{th}=f(t)$

$\Delta V/\Delta t=10dm^3/min; T_f=25^\circ C; 100\% wafer$

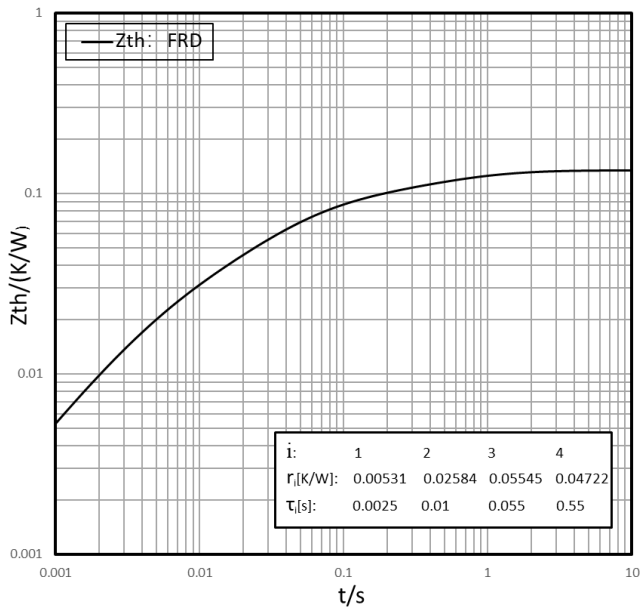

NTC-Thermistor-temperature characteristic

负温度系数热敏电阻 温度特性

$R=f(T)$

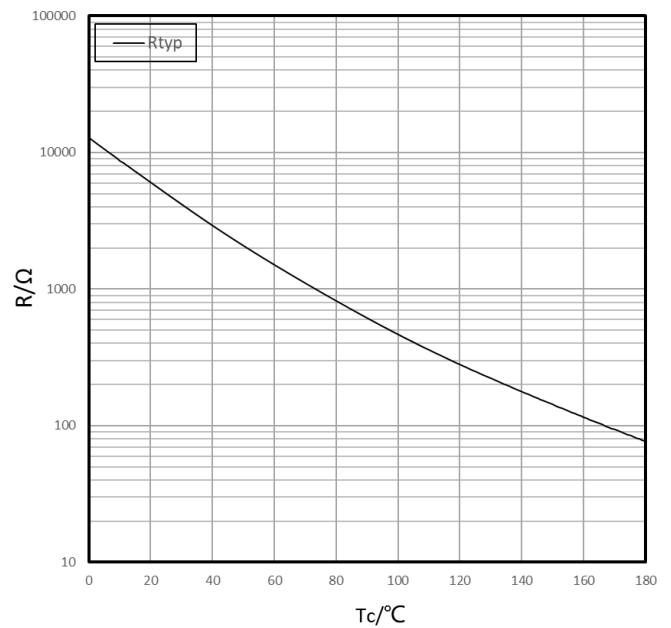

Internal Circuit / 内部电路

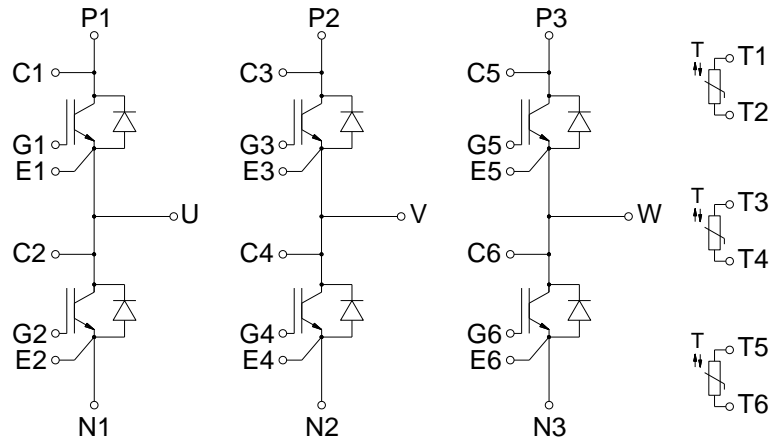

Package Dimension / 封装尺寸

Dimensions in Millimeters / 毫米为单位

